

seeglass **run**<sup>®3</sup>

Sliding enclosure system

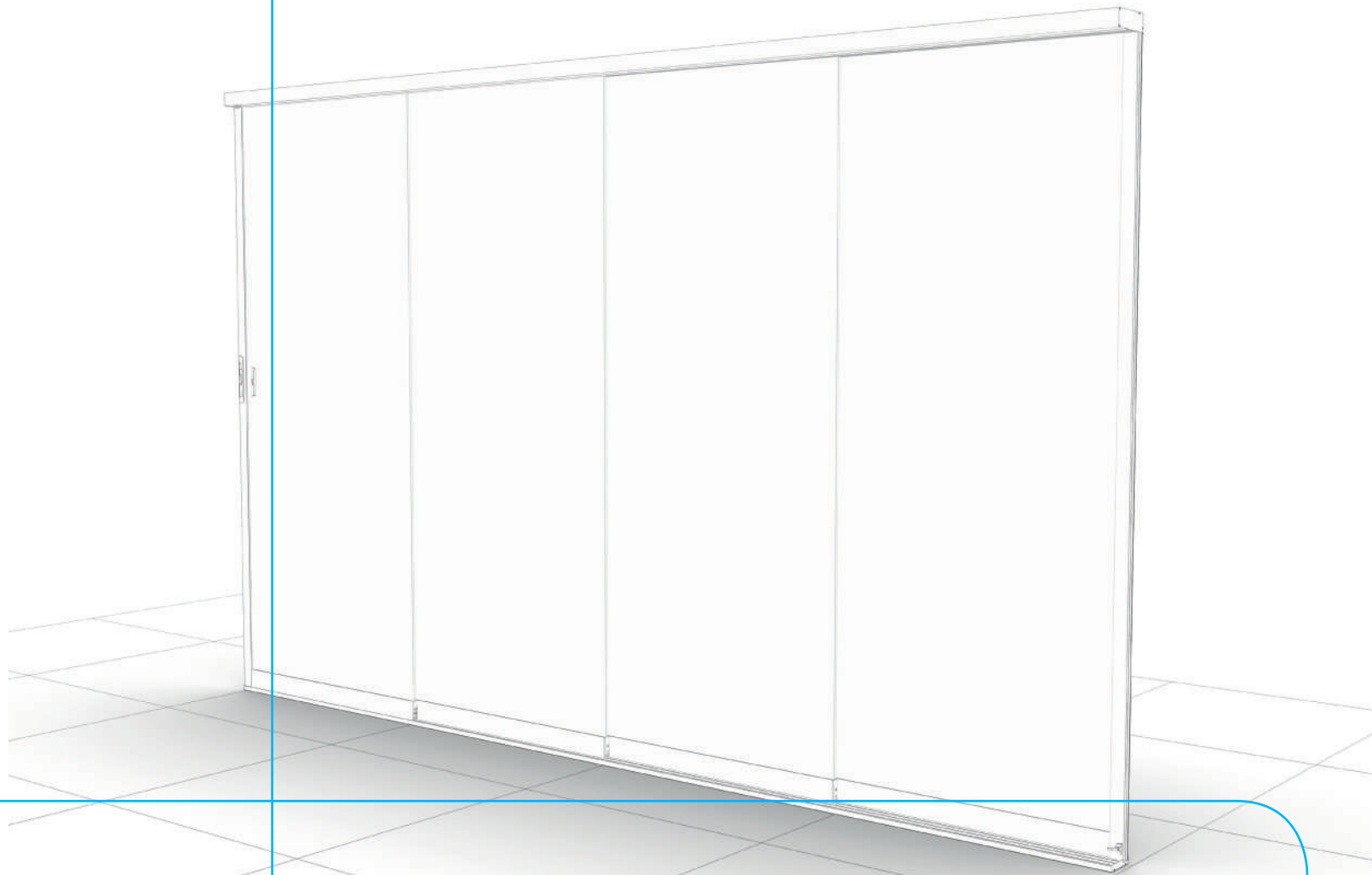

Bespoke sliding  
glass solutions for  
all spaces



New motorised glass curtain seeglass **m**run<sup>®</sup>

# seeglass®

## Index

Looking to the future

*pag. 2*

Product | seeglass **run**<sub>3</sub>

*pag. 3-4*

Details

*pag. 5-9*

Drives

*pag. 10*

Novelty | motorised option | seeglass **m** **run**<sub>3</sub>

*pag. 11-12*

Finishes

*pag. 13*

Certifications and tests

*pag. 14*



ANNIVERSARY

*opening the world*

## Looking to the future

Throughout these 15 years we have achieved many goals that have made us proud and have moved us forward. We have developed products that are increasingly efficient and respectful of our society and the planet we live in, we have created a fully personalised customer service and we have built strong and friendly relationships. We have also maintained a constant commitment to the training and development of our team, which has allowed us to stay at the forefront and make a difference.

Thank you all for your support and trust over the years.

Here's to many more years together!



## THE LATEST GENERATION OF GLASS CURTAINS



*Sliding enclosure Seeglass RUN 3 with central opening*

Introducing Seeglass m-RUN, the new motorised option. Designed for the user looking to combine advanced technology and exceptional functionality. At the touch of a button, enjoy a convenient and practical experience.

This option redefines the way we interact with the enclosure. Operate the system remotely via remote control, app or manually. At C3 Systems, we are committed to innovation and excellence, creating solutions that redefine everyday life.

Seeglass m-RUN is comfort and efficiency at the service of your needs, innovation that moves for you.

Seeglass RUN 3 has been created for people looking for design, elegance and uniqueness. We have updated one of our most emblematic systems, where the smoothness of the sliding and the optimisation of the use of space have taken precedence. The perfect solution to make every project stand out.

Create the ideal climate, enjoy nature and fill yourself with light. Fuse indoors and outdoors, transforming your space into a unique place.



*New motorised option, Seeglass m-RUN, operated via remote control with app.*

## ADVANTAGES OF THE SYSTEM

- New tandem wheels system that provides greater rolling smoothness and constant contact
- New ramp profile, allowing accessibility without obstacles.
- Protects the structure and elements of the space.
- Rolling on stainless steel profile
- New LED light in upper profiles
- It does not invade interior space when opened and allows unlimited vision.
- Maximum width panel: 1500mm.
- New motorised option. Control the system without effort.
- Ideal for HORECA and residential market.
- New opening devices integrated in sides profiles.
- Easy and quick montage
- Easy-to-use, clean and low-maintenance system.

## CONFIGURATIONS

The versatility of the **Seeglass-run 3** system allows to configure any geometric configuration left, right or central opening. And also intermediate openings, interior/exterior opening devices, linear sections, unions, all types of angles, height changes...etc.

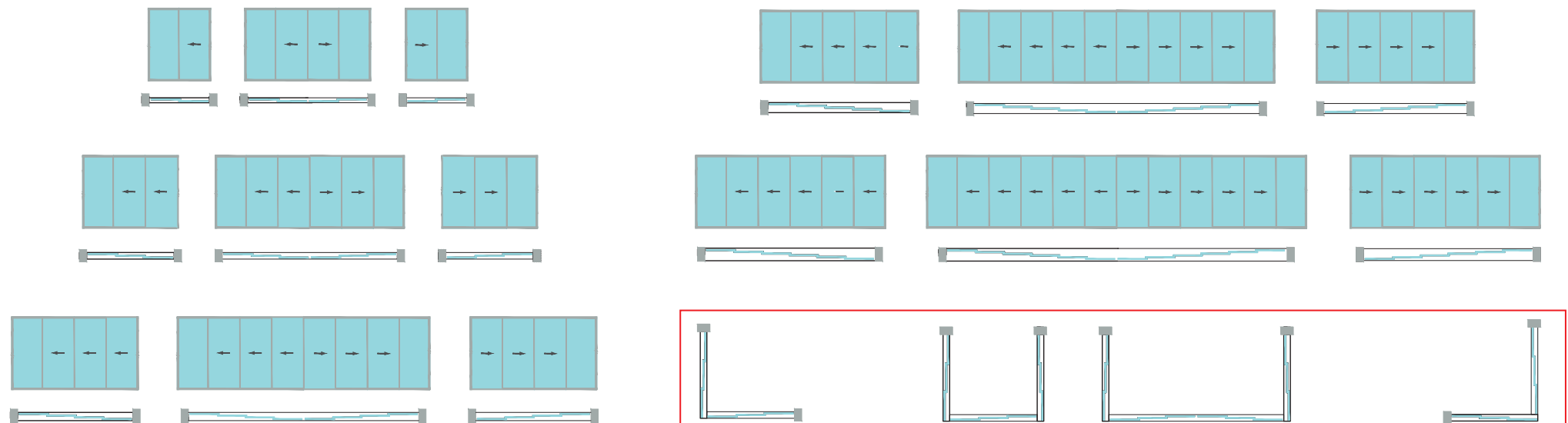

\*Representation of the most common configurations.

**90° ANGLE CONFIG.**

**COMING SOON!**



## TECHNICAL SPECIFICATIONS

TECHNICAL DATA			
No. of rails	2, 3, 4, 5, 6	Lower profile options	Standard or embedded
Glass thickness	10 mm Tempered	Glass clamping	Self-centering and MS adhesive
Maximum total height	3000 mm	Opening type	Sliding
Maximum total width	No limits	Panel weight location	Lower part



Maximum width panel 1500 mm\*



High quality bearings supporting up to 140 kg. panel



Tested in more than 25.000 opening cycles at maximum load



Quick and easy installation



Panel anti-tilt system



Anti-theft protection

*\*Depending on the height requested, the maximum panel width indicated may vary.*



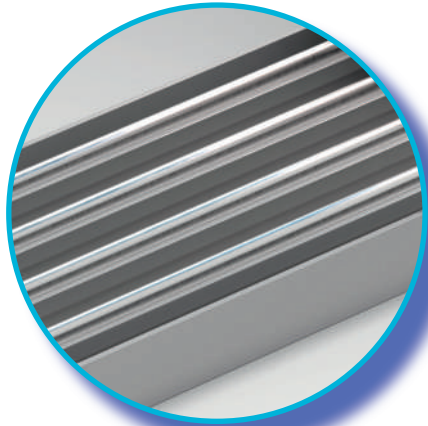

### ROLLING ON STAINLESS STEEL PROFILE

It offers exceptional resistance to wear and corrosion, preserving its original colour over time, ensuring smooth and efficient sliding at all times.



### PANELS HEIGHT REGULATION

The new self-locking function ensures that the adjustment remains fixed at all times.

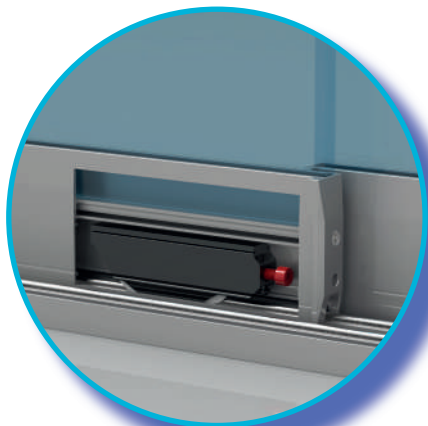

### SLIDING

Double bearing system to improve sliding, support more load and always maintain bearing contact with the rolling area.

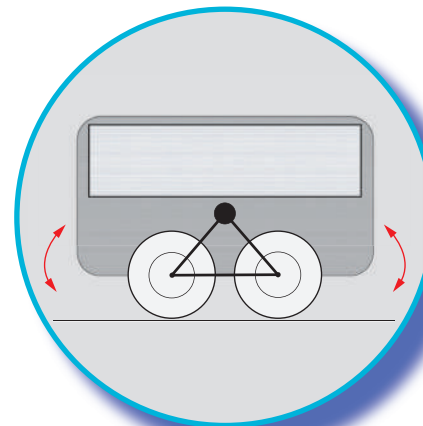

### CHASIS

The tandem-bearing chassis has a rocker mechanism that ensures smooth and efficient sliding while maintaining the verticality of the glasses.



## TECNICAL SECTIONS – STANDARD LOWER PROFILE

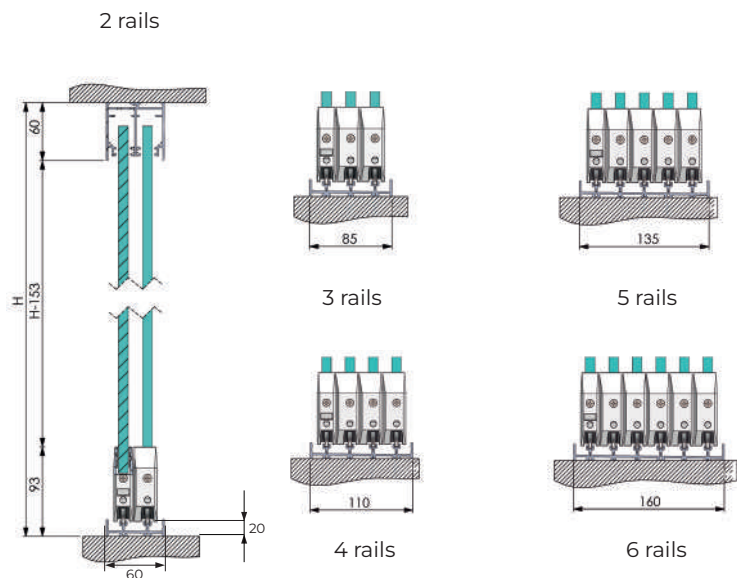

## TECNICAL SECTIONS – EMBEDDED LOWER PROFILE

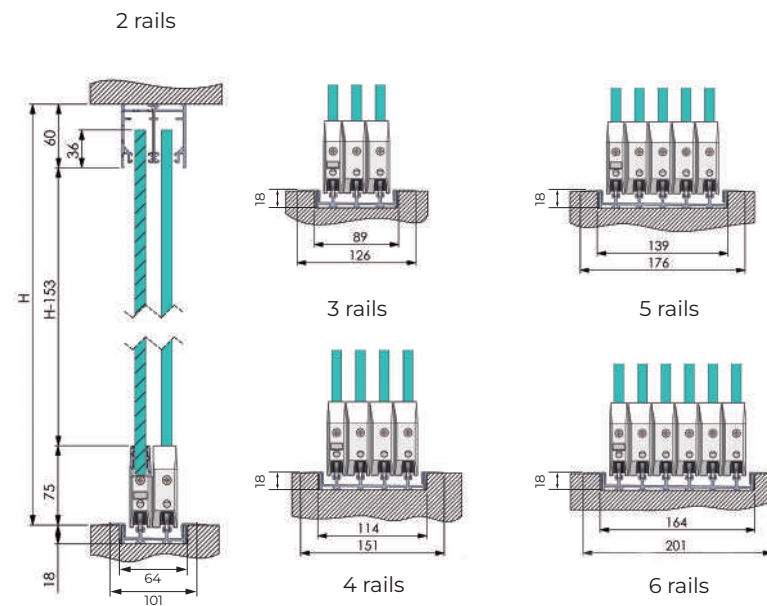

## TECNICAL SECTIONS – RAMP LOWER PROFILE

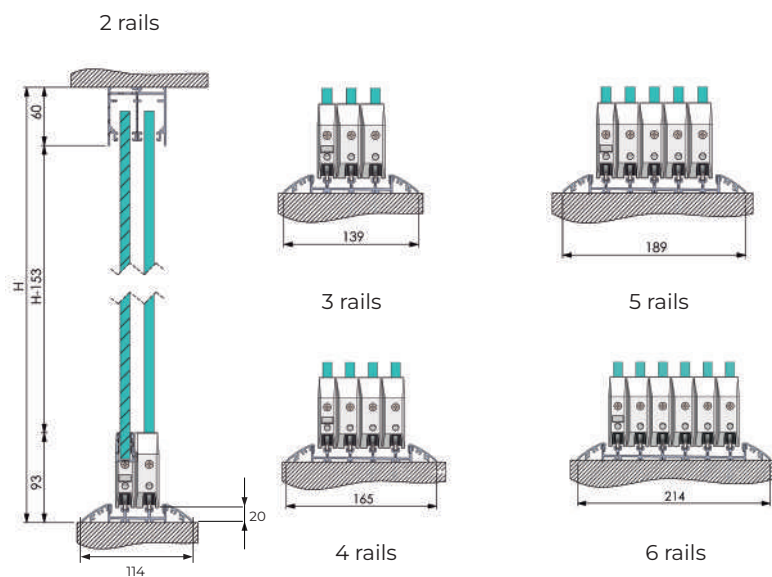

## TECNICAL SECTIONS – SIDES PROFILE

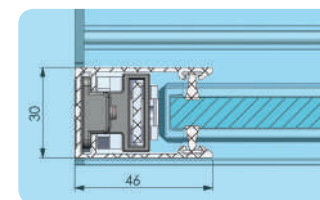

Side profile



### LOWER PROFILE STANDARD

The lower surface profile provides a smooth transition from the outside to the inside. Its height of 20 mm facilitates safe entry and exit from rooms.

### AUXILIARY EMBEDDED PROFILE

The lower profile recessed into the floor allows us to convert the surface profile into a profile recessed into the floor to avoid the step and facilitate the adjustment and finishing of the system on site. It creates a compensating effect to adapt to possible unevenness between the interior and exterior.



### AUXILIARY RAMP PROFILE

It converts the surface profile into a ramp, improving accessibility and facilitating passage for people with reduced mobility.

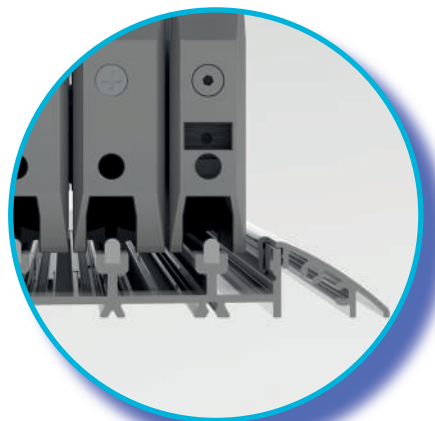

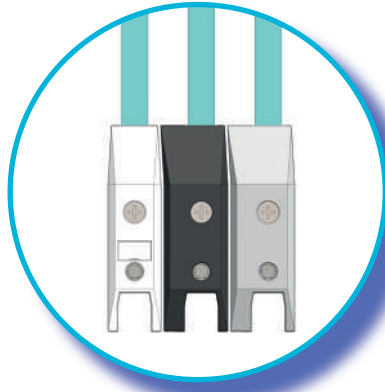

## PANEL CAP COVERS

Finishing available:  
-White  
-Matt Black  
-Matte Chrome

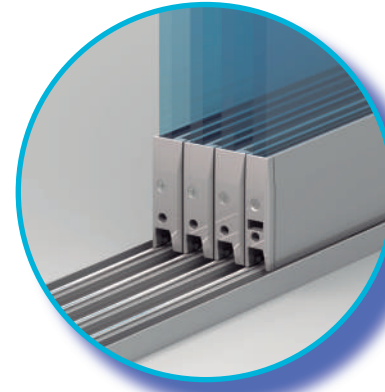

## FLUSH PANELS

Total alignment of the collected panels.



## SELF CLOSING INTEGRATED IN SIDES PROFILES

Opening and closing system from inside and/or outside.

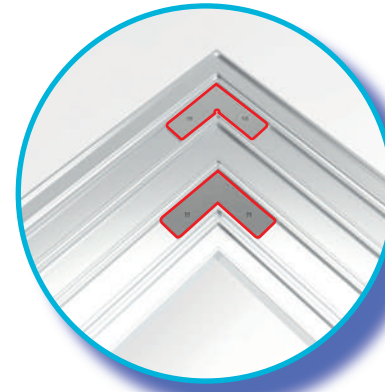

## UNION PIECES

These squares are used for a solid and secure connection between the upper and lower profiles, maintaining correct alignment. They are used for joining straight and 90° profiles.

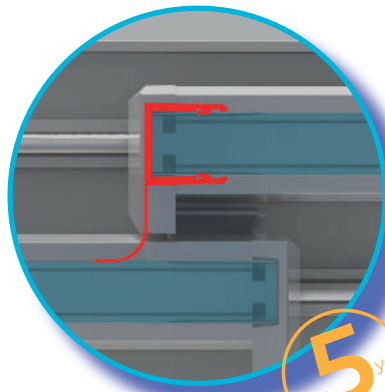

## GASKETS BETWEEN THE PANELS

The gaskets used by Seeglass systems are made of a material that is highly resistant to UV rays. Their main use is that they offer high protection against possible air and water leaks. Option of decorative aluminum joints with mat.

***We are the only company in the sector that guarantees\* the seals between glasses.***

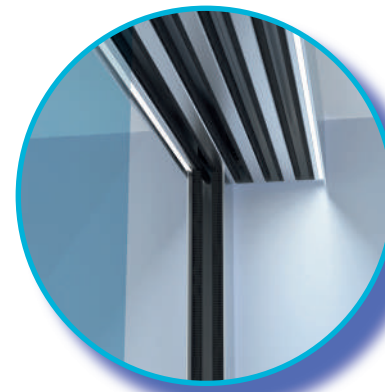

## LED LIGHT OPTION

Integrated into the upper profile, the 3000/4000K white LED lighting is ideal for ambient lighting.



\*5-year guarantee on 'Plus' plastic gaskets. Consult conditions.

## VERTICAL HANDLE

The new screw-fastened vertical handle design has a minimalist and ergonomic design.

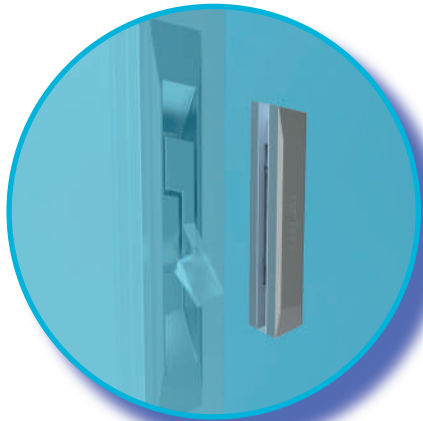

**Finishes:**  
White.  
Matt Black.  
Matt Chrome.

## EMBEDDED MANUAL DRIVE

The lock on the side of the system offers better integration and easy handling.

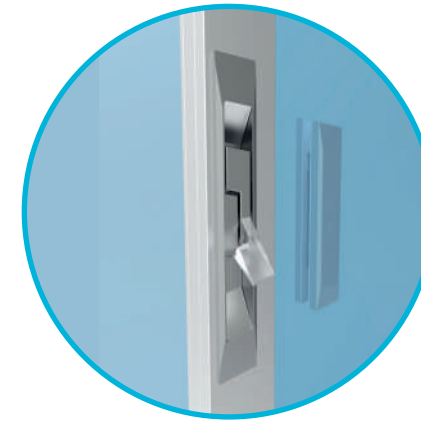

**Finishes:**  
White.  
Matt Black.

## KEY LOCK MODEL CD-6

Key-operated.



**Finishes:**  
Matt Black.  
Matt Chrome.

## LOWER LOCK

Optional bottom locking system integrated in the leaves. Necessary for 90° angles and in systems without side trim.

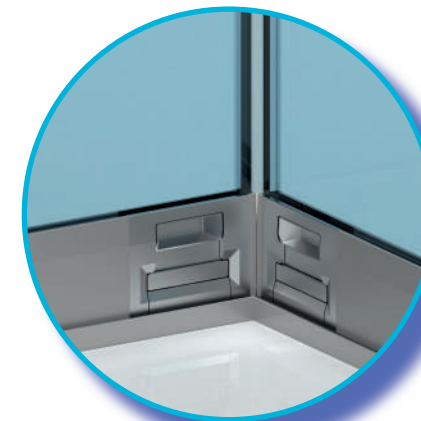

**Finishes:**  
White.  
Matt Black.



## The only glass curtain with integrated motorisation

This glass curtain system is unique in its class, developed with an exclusive motorisation specifically designed to integrate seamlessly into the system, without being an adaptation or third party solution. Its innovative technology allows smooth, efficient and silent operation, providing precise opening and closing control without external cables. The motorisation is integrated directly into the profile, which eliminates any additional components and enhances the aesthetics, creating a clean and elegant design.

It offers easy installation and intuitive use. Installers will enjoy the simplicity of its assembly and the robustness of the system, while end users will enjoy the convenience of controlling the curtains with a single touch. Thanks to its unique motorisation, an effortless sliding experience is guaranteed, ideal for all types of spaces, from residential to commercial. In addition, the system is designed for durability, maintaining its performance over time without the need for maintenance.









### ENGINE CHARACTERISTICS

Free space	Between 600 and 1500mm
Max. towable weight	300 kg
Opening speed	200 - 400 mm/s
Closing speed	200 mm/s
Quiet operation	< 50 dB
DC motor	24 V
Number of cycles	>250.000 cycles
Running motor power consumption	80 W
Temperature	Min -10°C Max 60°C







# Programmable Remote Control App by C3 Systems

## ADVANTAGES OF MOTORISATION

-  Patented system
-  Push & Go function
-  Low consumption
-  Ultra silent
-  Configurable opening and closing modes
-  Synchronised central opening
-  Automatic obstacle detection
-  Electronic blocking

## OPERATING MODES

-  Open door
-  Total opening
-  One touch
-  Closed
-  Block

## APPLICATIONS

-  Housing
-  Offices
-  Horeca





Seeglass RUN 3 is available in all finishes and colors.

Stock colors:



WHITE

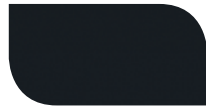

9011 MATT



9006 NATURE



7016 TX



7016 MATT



1013



8014



8017



ANODIZ. INOX



ANODIZ.  
SILVER MATT



Consulte disponibilidad, precio y plazo de entrega para otros acabados Carta RAL, anodizados e Imitación Madera

The aluminum profiles used to manufacture these articles comply with:

#### ALLOYS

UNE EN 12020-1  
UNE-EN 573-3  
UNE-EN 755-2.

#### LACQUERED SURFACE TREATMENT

The lacquered profiles are treated in approved facilities for the coating of architectural surfaces, in compliance with the specifications of the Quality Mark Guidelines.



*Why should we use aluminum for the enclosures of the future?*

#### **FOR ITS ENVIRONMENTAL ADVANTAGE**

*It is the only material used in enclosures that is 100% recyclable and reusable an infinite number of times.*

*It is the only one that is 100% sustainable and is effectively recycled.*

*The mineral with which it is produced is practically inexhaustible.*

*It is the only one that promotes the circular economy 100%.*



## APPROVALS AND TESTS

**Seeglass RUN 3** has test certificates in an approved laboratory, established by national and international legal regulations, issued by the corresponding certification companies.

This certification assures that choosing C3 Systems, S.L. products you are purchasing a quality product with all the necessary guarantees.

### MAXIMUM QUALIFICATION IN TEST\*



**Wind resistance**  
UNE EN 1932:2014  
**Class 6 - 113 km/h**



**Water thickness**  
UNE EN 1027:2017  
**Class 1A - 180 l/m<sup>2</sup>xhour**



**Pressure cycles**  
EP 0001:2024  
**100 cycles of 1200 Pa = 160 km/h.**



**\*Tested at dimensions (3400x2600mm)**



### CE Marking

All our systems are approved by an official laboratory and comply with the requirements of the European Commission to carry the CE Marking seal. We have all the tests and certificates that comply with these regulations and we have a computer tool that makes it easier for the workshop to obtain this label.



### Quality guarantee\*

The legal/commercial warranty period for Seeglass RUN is 3 years for all components.  
\*(Consult conditions of sale).





**MADE IN SPAIN**



C3 Systems, S.L. · C/ Ibi, 13 · P. I. Cachapets 03330 Crevillente (Alicante) España  
Telf. +34 966 286 186

[www.c3systems.es](http://www.c3systems.es)



ED. 3 - 2025

The purpose of this document is for commercial purpose. It does not constitute an authentic advertising offer in "strict sense". For the official offer, please contact C3 Systems S.L. in order to receive specific and personalized information that contains objective information regarding relevant characteristics which means that it will constitute an offer in a "strict sense".

C3 Systems S.L. commits not to make misleading advertising by this means. To these effects, therefore, formal or numerical errors that could be found in the content of this document are not considered as misleading advertising, in particular regarding to the image accompanying in an illustrative way, and not contractual. In any case C3 Systems S.L. commits to correct it as soon as it becomes aware of such errors.